

TO 6 PIN HI-ROSE CONNECTOR ON ASTRONOMICAL RESEARCH CAMERAS, INC. DUAL READOUT CONTROLLER AND TO AUXILIARY POWER SUPPLY

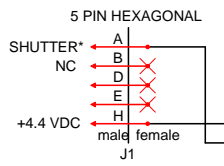

*: ACTIVE LOW TTL FROM CONTROLLER
NC: NO CONNECTION.

CLOSED WHEN ENERGIZED

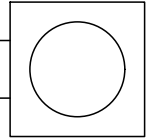
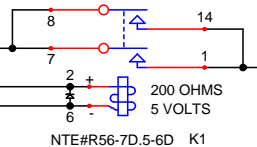

SHUTTER

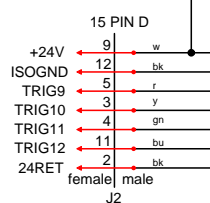

TRIG: ACTIVE LOW TTL TO 6K8

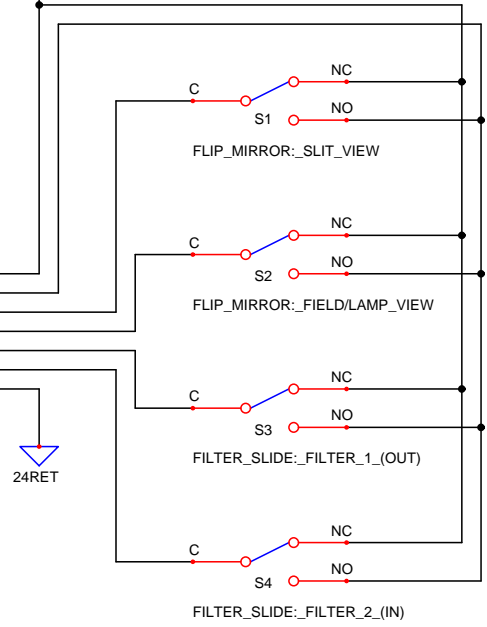

FOUR MICROSWITCHES

C: Common. NC: Normally Closed. NO: Normally Open
Filter slide is manually activated.

TO WIRO 8-AXIS CONTROLLER (COMPUMOTOR MODEL 6K8 AND IMS STEPPER MOTOR DRIVER MODEL IM483 FOR AXIS 5)

NC: NO CONNECTION.
*: COMPLIMENTARY PHASE OUTPUT: ACTIVE LOW TTL FROM 6K8

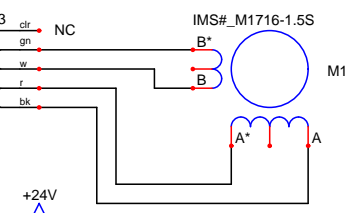
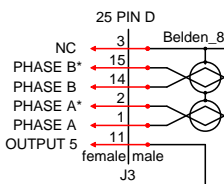

FLIP MIRROR MOTOR

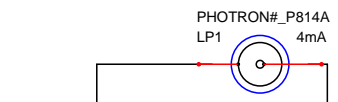
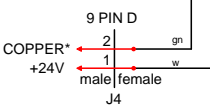

COPPER HOLLOW CATHODE COMPARISON LAMP

Lamp includes base and wired socket.

TO POWER SUPPLY FOR CALIBRATION LAMP, PHOTRON MODEL P209 (MODIFIED)

